

**ARTHUR WEBER AG**  
Postfach 753, CH - 6431 Schwyz

Verwaltung, CH - 6423 Seewen  
Wintersried 7, Tel. 041 819 06 06 Fax. 041 819 06 59

Absender / Name:

.....  
 .....  
 .....  
 .....



Termin & Lieferort:

.....  
 .....

Objekt:





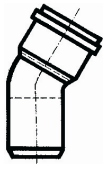

.....

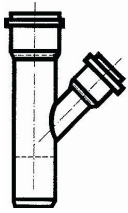
Bemerkung: Die angegebenen Mengen beziehen sich auf Paletten/Karton

Rohr	100	125	160	200	250	315
5 	(430)	(340)	(195)	(115)	(80)	(45)
5 	(430)	(340)	(195)	(115)	(80)	(45)

Bogen	100	125	160	200	250	315
	15°	(30)	(20)	(20)		
	30°	(30)	(20)	(20)		
	45°	(30)	(20)	(20)		
	67°	(30)	(20)	(20)		
	87°	(30)	(20)	(20)		
		(30)	(20)	(20)		

Gabeln 45°	100	125	160	200	250	315
	10	(20)	(20)	(20)		
	12		(20)	(20)		
	15			(20)		
	20					
	25					
	30					

Reduktionen	100	125	160	200	250	315
	10		(20)	(20)		
	12			(20)		
	15				(10)	
	20					
	25					
Muffen 	(30)	(20)	(20)	(10)		
Schachtfutter 						
Endverschlüsse 	(20)	(20)	(20)	(20)		
Anschluss-Stück 						
Schrumpfmuffe 						
Gleitmittel 	500 g			1000 g		

Zusätzliches Material:

.....  
 .....

Unterschrift: .....